

# WIND task chair family

Design by Baldanzi & Novelli designers | Italy



## QUALITY STANDARDS

- LST EN 1335 - 1:2000
- LST EN 1335 - 1:2000 / AC:2002
- LST EN 1335 - 2:2009
- LST EN 1335 - 3:2009
- LST EN 1335 - 3:2009 / AC:2009

## TECHNICAL INFORMATION

### Type

- Task chairs

### Seat

- Fixed or depth adjustable (60 mm run range);
- Lower part (inner and outer) made of PP (polypropylene);
- Foam made of polyurethane;
- Fabric or leather look upholstered.

### Backrest

- Frame made of black or white plastic;
- Mesh, fabric or leather look upholstered;
- Inner foam made of polyurethane (fabric upholstery).

### Lumbar support

- Height adjustable (80 mm run range);
- Made of transparent silicon.

### Armrests

- Fixed black plastic armrests;
- 2D (two directions) adjustable black plastic armrests.
- 2D (two directions) adjustable black plastic or white plastic armrests with polished aluminum lower part.
- 2D height adjustable armrests (80 mm run range), pad moves forward and backward (55 mm range).
- 3D (three directions) adjustable black plastic armrests.
- 3D (three directions) adjustable black plastic or white plastic armrests with polished aluminum lower part.
- 3D height adjustable armrests (80 mm run range), width adjustable (37 mm run range), pad moves forward and backward (55 mm range).
- All armrests upper part coated with PU (polyurethane) pads, soft touch.

## Headrest

- Frame made of nylon plastic;
- Soft part made of polyurethane;
- Height adjustable (60 mm run range);
- Fabric or leather look upholstered.

## Mechanism

- Weight-sensitive synchronized mechanism;
- 3 backrest locking positions by push button;
- Height adjustment by side lever.

## Gas lift

- Chromed or black color;
- 120 mm run range.

## Bases

- Five-star polished aluminium base;
- Five-star black or white fiberglass reinforced plastic base;
- External Ø700 mm.

## Castors

- Rubber free wheel castors for hard floor, Ø65 mm;
- PA (polyamide) free wheel castors for soft floor, Ø65 mm.

## RANGE

### With mesh backrest

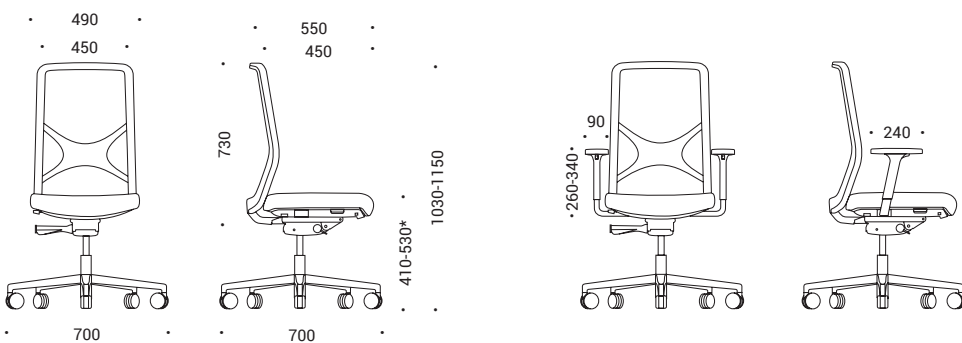

### With fabric backrest

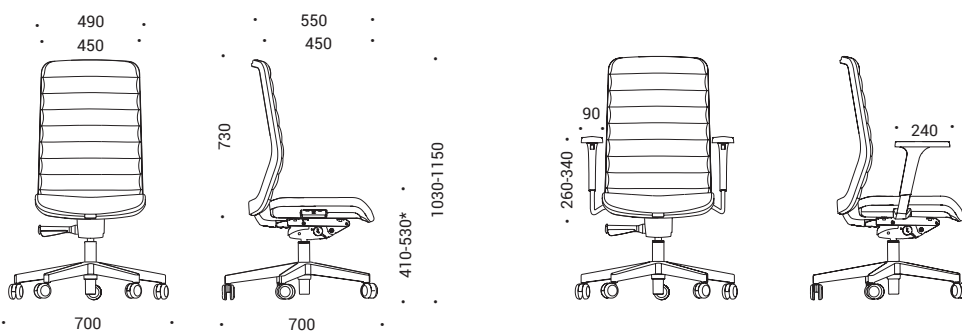

\* Height approved during certification.

## Optional



Fixed armrests



2D (two directions)  
adjustable armrests



3D (three directions)  
adjustable armrests



Headrest

# ORDERING EXAMPLE

## Code structure



Diagram showing the code structure for a chair with a mesh back and blue seat. The code is **SWA040 + AD6 MM1 X2**. The components are: Product (SWA040), Castor type (AD6), Fabric (MM1), Mesh fabric (B), and Lumbar support (X2). Castor options are Rubber castors (+) and Polyamide castors (-).



Diagram showing the code structure for a chair with a beige back and white seat. The code is **SWA240 - AD3 RM4 X2**. The components are: Product (SWA240), Castor type (AD3), Fabric (RM4), Mesh fabric (B), and Lumbar support (X2). Castor options are Rubber castors (+) and Polyamide castors (-).



















Diagram showing the code structure for a chair with a light blue back and seat. The code is **SWA440 + S55 X2**. The components are: Product (SWA440), Castor type (S55), Fabric (S55), Mesh fabric (B), and Lumbar support (X2). Castor options are Rubber castors (+) and Polyamide castors (-).





|  | Description   | W   | D   | H                 | SH           | Code   | Price, GBP (RRP)                           |  |  |                            |  |                         |
|--|---|-----|-----|-------------------|--------------|--------|--|--|--|----------------------------|--|-------------------------|
|  |   |     |     |                   |              |        | Castors: - +                               |  |  |                            |  |                         |
|  |   |     |     |                   |              |        | Fabric:                                    | Leather look/<br>Fabric:                               |  | Fabric:                    |  |                         |
|  |   |     |     |                   |              |        | <b>Bondai,<br/>Berta,<br/>Era</b>          | <b>RNN,<br/>Xtreme Plus,<br/>Step/Step<br/>Melange</b> |  | <b>Velito,<br/>Synergy</b> |  |                         |
|  |   |     |     |                   |              |        | Mesh/Knitted Fabric:                       |  |  |                            |  |                         |
|  |   |     |     |                   |              |        | <b>Micro<br/>Mesh,<br/>Runner<br/>Mesh</b> | <b>Knitted<br/>Mesh</b>                                | <b>Micro<br/>Mesh,<br/>Runner<br/>Mesh</b> | <b>Knitted<br/>Mesh</b>    | <b>Micro<br/>Mesh,<br/>Runner<br/>Mesh</b> | <b>Knitted<br/>Mesh</b> |
|  |   |     |     |                   |              |        | Lumbar support: X2                         |  |  |                            |  |                         |
|    | Task chair. Backrest upholstered with mesh. Height adjustable lumbar support. Made of transparent silicon. Weight-sensitive synchronized mechanism with 3 locking positions. Black plastic chair frame. Black plastic 5 star base with fiberglass. 65 mm castors.             | 700 | 700 | 1030<br>-<br>1150 | 410 -<br>530 | SWA040 | <b>556</b>                                 | <b>568</b>   | <b>560</b>                                 | <b>572</b>                 | <b>580</b>                                 | <b>596</b>              |
|  | Task chair. Backrest upholstered with mesh. Height adjustable lumbar support. Made of transparent silicon. Slide seat. Weight-sensitive synchronized mechanism with 3 locking positions. Black plastic chair frame. Black plastic 5 star base with fiberglass. 65 mm castors. | 700 | 700 | 1030<br>-<br>1150 | 410 -<br>530 | SWA050 | <b>596</b>                                 | <b>604</b>   | <b>600</b>                                 | <b>612</b>                 | <b>620</b>                                 | <b>632</b>              |
|  | Task chair. Backrest upholstered with mesh. Height adjustable lumbar support. Made of transparent silicon. Weight-sensitive synchronized mechanism with 3 locking positions. Black plastic chair frame. Polished aluminium 5 star base. 65 mm castors.                        | 700 | 700 | 1030<br>-<br>1150 | 410 -<br>530 | SWA140 | <b>616</b>                                 | <b>632</b>   | <b>620</b>                                 | <b>632</b>                 | <b>644</b>                                 | <b>656</b>              |
|  | Task chair. Backrest upholstered with mesh. Height adjustable lumbar support. Made of transparent silicon. Slide seat. Weight-sensitive synchronized mechanism with 3 locking positions. Black plastic chair frame. Polished aluminium 5 star base. 65 mm castors.            | 700 | 700 | 1030<br>-<br>1150 | 410 -<br>530 | SWA150 | <b>652</b>                                 | <b>668</b>   | <b>660</b>                                 | <b>676</b>                 | <b>684</b>                                 | <b>692</b>              |

|  | Description   | W   | D   | H                 | SH           | Code   | Price, GBP (RRP)                  |                         |  |                         |                            |                         |
|--|---|-----|-----|-------------------|--------------|--------|-----------------------------------|-------------------------|--|-------------------------|----------------------------|-------------------------|
| W - width<br>D - depth<br>H - height<br>SH - seat height                           |   |     |     |                   |              |        | Castors: - +                      |                         |  |                         |                            |                         |
|  |   |     |     |                   |              |        | Fabric:                           |                         | Leather look/<br>Fabric:                               |                         | Fabric:                    |                         |
|  |   |     |     |                   |              |        | <b>Bondai,<br/>Berta,<br/>Era</b> |                         | <b>RNN,<br/>Xtreme Plus,<br/>Step/Step<br/>Melange</b> |                         | <b>Velito,<br/>Synergy</b> |                         |
|  |   |     |     |                   |              |        | Mesh/Knitted Fabric:              |                         |  |                         |                            |                         |
|  |   |     |     |                   |              |        | <b>Runner<br/>Mesh</b>            | <b>Knitted<br/>Mesh</b> | <b>Runner<br/>Mesh</b>                                 | <b>Knitted<br/>Mesh</b> | <b>Runner<br/>Mesh</b>     | <b>Knitted<br/>Mesh</b> |
|  |   |     |     |                   |              |        | Lumbar support: X2                |                         |  |                         |                            |                         |
|    | Task chair. Backrest upholstered with mesh. Height adjustable lumbar support. Made of transparent silicon. Weight-sensitive synchronized mechanism with 3 locking positions. White plastic chair frame. White plastic 5 star base with fiberglass. 65 mm castors.             | 700 | 700 | 1030<br>-<br>1150 | 410 -<br>530 | SWA240 | <b>572</b>                        | <b>584</b>              | <b>576</b>   | <b>588</b>              | <b>600</b>                 | <b>612</b>              |
|   | Task chair. Backrest upholstered with mesh. Height adjustable lumbar support. Made of transparent silicon. Slide seat. Weight-sensitive synchronized mechanism with 3 locking positions. White plastic chair frame. White plastic 5 star base with fiberglass. 65 mm castors. | 700 | 700 | 1030<br>-<br>1150 | 410 -<br>530 | SWA250 | <b>612</b>                        | <b>624</b>              | <b>616</b>   | <b>632</b>              | <b>636</b>                 | <b>652</b>              |
|  | Task chair. Backrest upholstered with mesh. Height adjustable lumbar support. Made of transparent silicon. Weight-sensitive synchronized mechanism with 3 locking positions. White plastic chair frame. Polished aluminium 5 star base. 65 mm castors.                        | 700 | 700 | 1030<br>-<br>1150 | 410 -<br>530 | SWA340 | <b>632</b>                        | <b>648</b>              | <b>636</b>   | <b>652</b>              | <b>660</b>                 | <b>676</b>              |
|  | Task chair. Backrest upholstered with mesh. Height adjustable lumbar support. Made of transparent silicon. Slide seat. Weight-sensitive synchronized mechanism with 3 locking positions. White plastic chair frame. Polished aluminium 5 star base. 65 mm castors.            | 700 | 700 | 1030<br>-<br>1150 | 410 -<br>530 | SWA350 | <b>668</b>                        | <b>688</b>              | <b>680</b>   | <b>688</b>              | <b>696</b>                 | <b>716</b>              |



|  | Description  | W   | D   | H                 | SH           | Code   | Price, GBP (RRP)                  |  |                            |
|--|--|-----|-----|-------------------|--------------|--------|-----------------------------------|--|----------------------------|
|  |  |     |     |                   |              |        | Castors: - +                      |  |                            |
|  |  |     |     |                   |              |        | Fabric:                           | Leather look/<br>Fabric:                               | Fabric:                    |
|  |  |     |     |                   |              |        | <b>Bondai,<br/>Berta,<br/>Era</b> | <b>RNN,<br/>Xtreme Plus,<br/>Step/Step<br/>Melange</b> | <b>Velito,<br/>Synergy</b> |
|  |  |     |     |                   |              |        | Lumbar support: X2                |  |                            |
|    | Task chair. Backrest upholstered with fabric. Height adjustable lumbar support made of transparent silicon. Weight-sensitive synchronized mechanism with 3 locking positions. Black plastic chair frame. Black plastic 5 star base with fiberglass. 65 mm castors.             | 700 | 700 | 1030<br>-<br>1150 | 410 -<br>530 | SWA440 | <b>612</b>                        | <b>652</b>   | <b>716</b>                 |
|   | Task chair. Backrest upholstered with fabric. Height adjustable lumbar support made of transparent silicon. Slide seat. Weight-sensitive synchronized mechanism with 3 locking positions. Black plastic chair frame. Black plastic 5 star base with fiberglass. 65 mm castors. | 700 | 700 | 1030<br>-<br>1150 | 410 -<br>530 | SWA450 | <b>648</b>                        | <b>688</b>   | <b>748</b>                 |
|  | Task chair. Backrest upholstered with fabric. Height adjustable lumbar support made of transparent silicon. Weight-sensitive synchronized mechanism with 3 locking positions. Black plastic chair frame. Polished aluminium 5 star base. 65 mm castors.                        | 700 | 700 | 1030<br>-<br>1150 | 410 -<br>530 | SWA540 | <b>676</b>                        | <b>720</b>   | <b>776</b>                 |
|  | Task chair. Backrest upholstered with fabric. Height adjustable lumbar support made of transparent silicon. Slide seat. Weight-sensitive synchronized mechanism with 3 locking positions. Black plastic chair frame. Polished aluminium 5 star base. 65 mm castors.            | 700 | 700 | 1030<br>-<br>1150 | 410 -<br>530 | SWA550 | <b>716</b>                        | <b>752</b>   | <b>816</b>                 |



|  | Description  | W   | D   | H                 | SH           | Code   | Price, GBP (RRP)                  |  |                            |
|--|--|-----|-----|-------------------|--------------|--------|-----------------------------------|--|----------------------------|
|  |  |     |     |                   |              |        | Castors: - +                      |  |                            |
|  |  |     |     |                   |              |        | Fabric:                           | Leather look/<br>Fabric:                               | Fabric:                    |
|  |  |     |     |                   |              |        | <b>Bondai,<br/>Berta,<br/>Era</b> | <b>RNN,<br/>Xtreme Plus,<br/>Step/Step<br/>Melange</b> | <b>Velito,<br/>Synergy</b> |
|  |  |     |     |                   |              |        | Lumbar support: X2                |  |                            |
|    | Task chair. Backrest upholstered with fabric. Height adjustable lumbar support made of transparent silicon. Weight-sensitive synchronized mechanism with 3 locking positions. White plastic chair frame. White plastic 5 star base with fiberglass. 65 mm castors.             | 700 | 700 | 1030<br>-<br>1150 | 410 -<br>530 | SWA640 | <b>624</b>                        | <b>668</b>   | <b>724</b>                 |
|   | Task chair. Backrest upholstered with fabric. Height adjustable lumbar support made of transparent silicon. Slide seat. Weight-sensitive synchronized mechanism with 3 locking positions. White plastic chair frame. White plastic 5 star base with fiberglass. 65 mm castors. | 700 | 700 | 1030<br>-<br>1150 | 410 -<br>530 | SWA650 | <b>664</b>                        | <b>712</b>   | <b>764</b>                 |
|  | Task chair. Backrest upholstered with fabric. Height adjustable lumbar support made of transparent silicon. Weight-sensitive synchronized mechanism with 3 locking positions. White plastic chair frame. Polished aluminium 5 star base. 65 mm castors.                        | 700 | 700 | 1030<br>-<br>1150 | 410 -<br>530 | SWA740 | <b>688</b>                        | <b>732</b>   | <b>788</b>                 |
|  | Task chair. Backrest upholstered with fabric. Height adjustable lumbar support made of transparent silicon. Slide seat. Weight-sensitive synchronized mechanism with 3 locking positions. White plastic chair frame. Polished aluminium 5 star base. 65 mm castors.            | 700 | 700 | 1030<br>-<br>1150 | 410 -<br>530 | SWA750 | <b>724</b>                        | <b>768</b>   | <b>828</b>                 |

|   | Description   | W   | D   | H            | SH | Code     | Price, GBP (RRP)                  |  |                            |                 |
|---|---|-----|-----|--------------|----|----------|-----------------------------------|--|----------------------------|-----------------|
| W - width<br>D - depth<br>H - height<br>SH - seat height                            |   |     |     |              |    |          | Fabric:                           | Leather look/<br>Fabric:                                   | Fabric:                    | Genuine leather |
|   |   |     |     |              |    |          | <b>Bondai,<br/>Berta,<br/>Era</b> | <b>RNN,<br/>Xtreme<br/>Plus,<br/>Step/Step<br/>Melange</b> | <b>Velito,<br/>Synergy</b> | <b>DNN</b>      |
|    | Fixed and height adjustable headrest upholstered with fabric or leather   | 280 | 153 | 295          |    | SZZ006   | <b>72</b>                         | <b>76</b>  | <b>84</b>                  | <b>88</b>       |
|   |   |     |     |              |    |          | Accessories                       |  |                            |                 |
|    | Fixed black plastic armrests (2pcs.)  | 240 | 190 | 300          |    | SZZ001-A |                                   |  |                            | <b>88</b>       |
|   | 2D (two directions) adjustable black plastic armrests. Upper part coated with a PU (polyurethane) pads, soft touch. Adjustable in height, top moving forward and backward. (2pcs.)  | 240 | 195 | 260 -<br>340 |    | SZZ102-A |                                   |  |                            | <b>128</b>      |
|  | 2D (two directions) adjustable black plastic armrests with polished aluminium lower part. Upper part coated with black PU (polyurethane) pads, soft touch. Adjustable in height, top moving forward and backward. (2pcs.) | 240 | 195 | 260 -<br>340 |    | SZZ103-A |                                   |  |                            | <b>160</b>      |
|  | 2D (two directions) adjustable white plastic armrests with polished aluminium lower part. Upper part coated with black PU (polyurethane) pads, soft touch. Adjustable in height, top moving forward or backward. (2 pcs.) | 240 | 195 | 260 -<br>340 |    | SZZ110-E |                                   |  |                            | <b>168</b>      |



|   | Description  | W   | D   | H         | SH | Code     | Price, GBP (RRP) |
|---|--|-----|-----|-----------|----|----------|------------------|
|   |  |     |     |           |    |          | Accessories      |
|    | 3D (three directions) adjustable black plastic armrests. Upper part coated with a PU (polyurethane) pads, soft touch. Adjustable in height, width, top moving forward and backward. (2pcs.)  | 240 | 195 | 260 - 340 |    | SZZ111-A | <b>156</b>       |
|    | 3D (three directions) adjustable black plastic armrests with polished aluminium lower part. Upper part coated with black PU (polyurethane) pads, soft touch. Adjustable in height, width, top moving forward and backward. (2pcs.) | 240 | 195 | 260 - 340 |    | SZZ112-A | <b>196</b>       |
|  | 3D (three directions) adjustable white plastic armrests with polished aluminium lower part. Upper part coated with black PU (polyurethane) pads, soft touch. Adjustable in height, width, top moving forward or backward. (2 pcs.) | 240 | 195 | 260 - 340 |    | SZZ113-E | <b>204</b>       |